



Mahr | A passion for detail

Edition
2024

Spring Sale

Mobile roughness measurement with the MarSurf M 310

- Intuitive and easy to operate like a smartphone
- Immediate measuring success thanks to program start via barcode scanner
- Uncomplicated digital connection to QM systems



Special offer prices
April 1 - May 31, 2024

Comprehensive product range with Integrated Wireless

3

Product groups

85

Products

Mahr offers a comprehensive range of measuring instruments with integrated wireless data transmission for use in all areas of industrial manufacturing and quality control. The Integrated Wireless range from Mahr delivers accurate measuring results with full mobility. Modern, simple measuring solutions – without the limitations of wired technology.



MarCal 16 EWri

Digital calipers



MarCator 1086 Ri

Digital indicators



Micromar 40 EWri

Digital outside micrometers



MarCator 1086 Ri
with stand

Digital indicators



MarCator 1086 Ri
with 3-point pistol

Digital indicator



Millimes
2001 Wi

Digital
comparator



MarCator 1087 Ri
with SM 60

Digital indicator

Detailed information on the products can be found at <https://metrology.mahr.com/en-int/>
All illustrations and figures etc. are without guarantee. All prices quoted are non-binding recommended prices. The net prices in € plus VAT are valid from April 1, 2024 to May 31, 2024

MarCal 16 EWRI / 30 EWRI

Digital calipers with wireless interface

Spring Sale



199.00
MarCal 16 EWRI

4103400

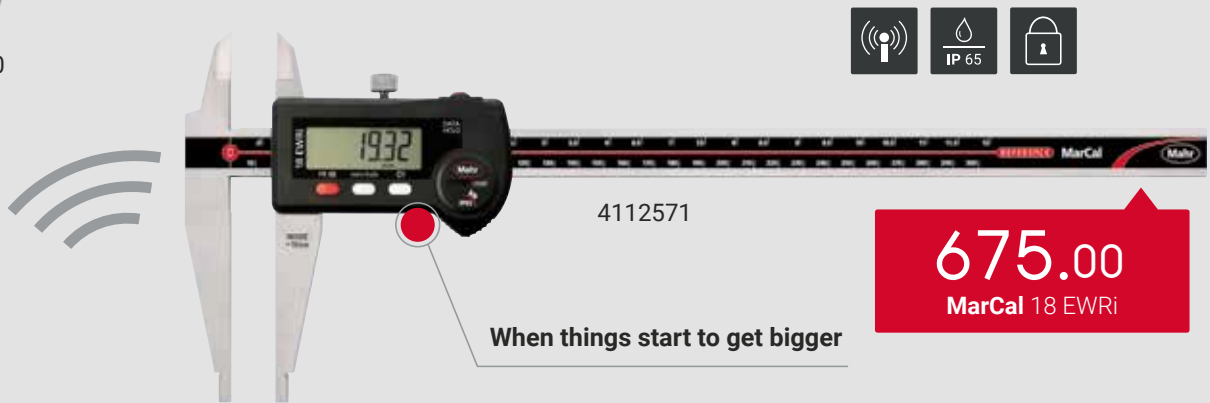

675.00
MarCal 18 EWRI

4112571

When things start to get bigger



299.00
MarCal 30 EWRI

4126751

Compact and handy

always within reach



398.00
MarCal 30 EWRI

4126671

Order no.	Product	Measuring range	Resolution	Depth rod	Details	List price	Offer price
		mm	mm			EUR	EUR
4103400	16 EWRI	0 – 150	0.01	round	With measuring blades	268.00	199.00
4103402	16 EWRI	0 – 150	0.01	square	With measuring blades	268.00	199.00
9105795	16 EWRI	0 – 150	0.01	round	Starter pack incl. i-Stick	386.50	269.00
9105796	16 EWRI	0 – 150	0.01	square	Starter pack incl. i-Stick	386.50	269.00
4112571	18 EWRI	0 – 300	0.01		With measuring blades	843.00	675.00
4112572	18 EWRI	0 – 500	0.01		With measuring blades	1095.00	876.00
4126671	30 EWRI	0 – 150	0.01		With measuring pin Ø 1,5 mm	498.00	398.00
4126672	30 EWRI	0 – 200	0.01		With measuring pin Ø 1,5 mm	564.00	451.00
4126673	30 EWRI	0 – 300	0.01		With measuring pin Ø 1,5 mm	648.00	518.00
4126751	30 EWRI	0 – 25	0.01		With measuring pin Ø 2 mm	375.00	299.00

Accessories for measuring instruments with Integrated Wireless							
4102220	i-Stick	Wireless receiver for measuring instruments with integrated wireless				118.50	95.00

Detailed information on the products can be found at <https://metrology.mahr.com/en-int/>
 All illustrations and figures etc. are without guarantee. All prices quoted are non-binding recommended prices. The net prices in € plus VAT are valid from April 1, 2024 to May 31, 2024

Micromar 40 EWRI

Micrometers according to your wishes

Spring Sale

275.00
Micromar 40 EWRI

4157100

343.00
Micromar 40 EWRI-L

4157120

995.00
Micromar 40 EWRI-V SET

40 EWRI-V Set 4157150

Order no.	Product	Measuring range	Resolution	Details	List price	Offer price
		mm	mm		EUR	EUR
4157100	40 EWRI	0 – 25	0.001	Standard version	344.00	275.00
4157101	40 EWRI	25 – 50	0.001	Standard version	406.00	325.00
4157115	40 EWRI	0 – 100	0.001	Standard version. set with 4 micrometers	1020.00	1456.00
4157120	40 EWRI-L	0 – 25	0.001	QUICK DRIVE, 5 mm per rotation	429.00	343.00
4157121	40 EWRI-L	25 – 50	0.001	QUICK DRIVE, 5 mm per rotation	489.00	391.00
4157150	40 EWRI-V		0.001	Universal micrometer (QUICK DRIVE) incl. measuring anvils	1250.00	995.00
Accessories for measuring instruments with Integrated Wireless						
4102220	i-Stick	Wireless receiver for measuring instruments with integrated wireless			118.50	95.00

Detailed information on the products can be found at <https://metrology.mahr.com/en-int/>
All illustrations and figures etc. are without guarantee. All prices quoted are non-binding recommended prices. The net prices in € plus VAT are valid from April 1, 2024 to May 31, 2024

MarCator 1086 Ri / 1087 Ri

Practically suited to your measuring tasks



4337663



477.00

MarCator 1087 Ri



4337624



408.00

MarCator 1086 Ri

Millimes | Inductive dial comparators

Millimes 2000 Wi / 2001 Wi

see also page 14



4346701

622.00

Millimes 2000 Wi



4346801

699.00

Millimes 2001 Wi

Order no.	Product	Measuring range	Resolution	Details	List price	Offer price
		mm	mm		EUR	EUR
4337624	1086 Ri	12.5	0.0005	Practical functions for static measurement tasks	510.00	408.00
4337625	1086 Ri	25	0.0005	Practical functions for static measurement tasks	576.00	461.00
4337663	1087 Ri	12.5	0.0005	Practical functions for static and dynamic measurement tasks	597.00	477.00
4337665	1087 Ri	25	0.0005	Practical functions for static and dynamic measurement tasks	675.00	540.00
4346701	2000 Wi	± 1	0.0001	Highest sensitivity and accuracy, for static measuring tasks	777.00	622.00
4346801	2001 Wi	± 1	0.0001	Highest sensitivity and accuracy, for static and dynamic measuring tasks	876.00	699.00

Accessories for measuring instruments with Integrated Wireless

4102220	i-Stick	Wireless receiver for measuring instruments with integrated wireless	118.50	95.00
---------	---------	----------------------------------------------------------------------	-------------------	-------

Detailed information on the products can be found at <https://metrology.mahr.com/en-int/>
 All illustrations and figures etc. are without guarantee. All prices quoted are non-binding recommended prices. The net prices in € plus VAT are valid from April 1, 2024 to May 31, 2024

MarCal 16 ER / 16 EWR

Digital calipers without data output

Spring Sale

Best Price – Best Quality!

The standard
in the workshop

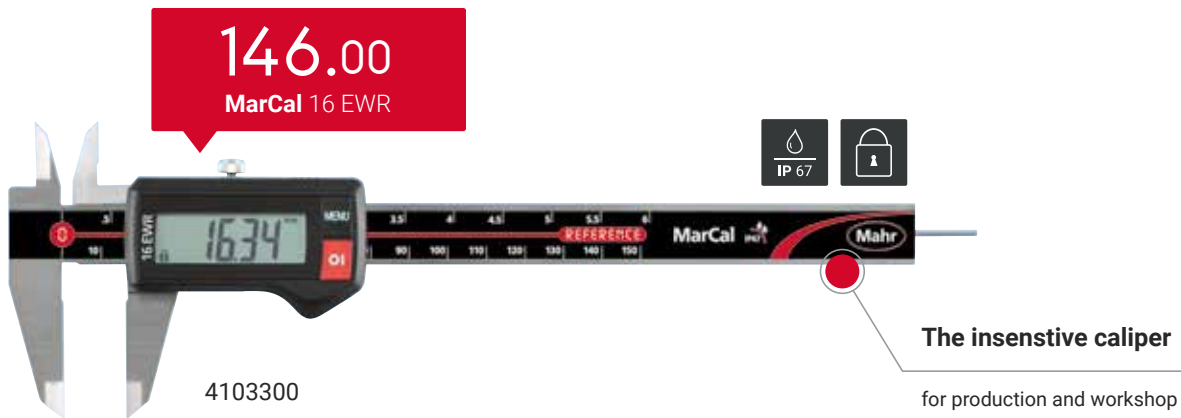

Order no.	Product	Measuring range	Resolution	Depth rod	Details	List price	Offer price
		mm	mm			EUR	EUR
4103010	16 ER	0 – 150	0.01	round	Lapped guideway	131.50	98.00
4103012	16 ER	0 – 150	0.01	square	Lapped guideway	131.50	98.00
4103205	16 ER	0 – 200	0.01	square	Lapped guideway	214.50	172.00
4103300	16 EWR	0 – 150	0.01	round	Protection class IP 67	195.50	146.00
4103302	16 EWR	0 – 150	0.01	square	Protection class IP 67	195.50	146.00
4103304	16 EWR	0 – 200	0.01	square	Protection class IP 67	282.00	226.00

Detailed information on the products can be found at <https://metrology.mahr.com/en-int/>
 All illustrations and figures etc. are without guarantee. All prices quoted are non-binding recommended prices. The net prices in € plus VAT are valid from April 1, 2024 to May 31, 2024

MarCal 30 EWR

Digital depth gages



Spring Sale

Order no.	Product	Measuring range	Resolution	Details	List price	Offer price
		mm	mm		EUR	EUR
4126651	30 EWR	0 – 150	0.01	Protection class IP67	436.00	349.00
4126652	30 EWR	0 – 200	0.01	Protection class IP67	507.00	406.00
4126653	30 EWR	0 – 300	0.01	Protection class IP67	576.00	461.00

MarCal 16 FN

Pocket calipers

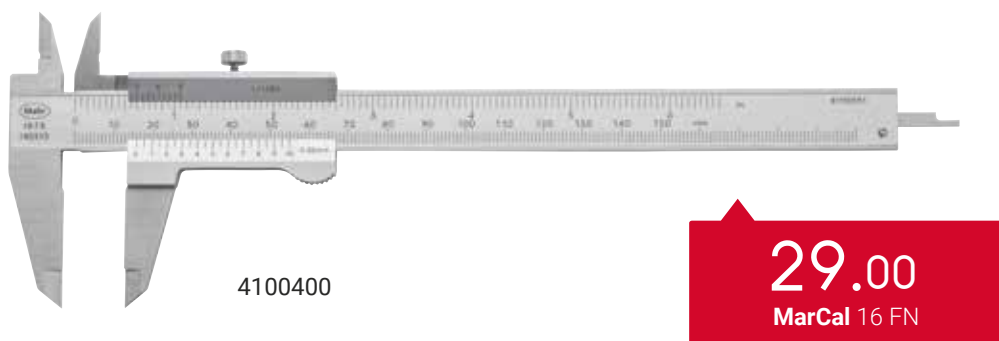

Order no.	Product	Measuring range	Vernier value	Depth rod	List price	Offer price
		mm	mm/inch		EUR	EUR
4100400	16 FN	0 – 150	0.05/1/128"	square	36.25	29.00
4100401	16 FN	0 – 200	0.05/1/128"	square	98.50	79.00

Micromar 40 ER / 40 EWR

The insensitive ones for production and workshop

Spring Sale



156.00
Micromar 40 ER

4157010

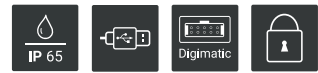

334.00
Micromar 40 EWR-L

4157020



972.00
Micromar 40 EWR-V

4157050

Order no.	Product	Measuring range	Resolution	Details	List price	Offer price
		mm	mm		EUR	EUR
4157010	40 ER	0 – 25	0.001	Protection class IP40	195.50	156.00
4157011	40 EWR	0 – 25	0.001	Protection class IP65	243.50	195.00
4157012	40 EWR	25 – 50	0.001	Protection class IP65	337.00	270.00
4157020	40 EWR-L	0 – 25	0.001	IP65, data output, QUICK DRIVE, 5 mm per rotation	417.00	334.00
4157021	40 EWR-L	25 – 50	0.001	IP65, data output, QUICK DRIVE, 5 mm per rotation	476.00	381.00
4157050	40 EWR-V	0 – 25	0.001	IP65, data output, universal micrometer QUICK DRIVE in a set	1215.00	972.00

Detailed information on the products can be found at <https://metrology.mahr.com/en-int/>
 All illustrations and figures etc. are without guarantee. All prices quoted are non-binding recommended prices. The net prices in € plus VAT are valid from April 1, 2024 to May 31, 2024

Micromar 40 A / 40 SA / 40 AS

Basics for production and workshop

Outside micrometers with hard lacquered steel frame



4134000

53.00
Micromar 40 A



309.00
Micromar 40 SA/SET

4134050

3-point inside micrometers suited for blind bores (from 12mm)



1792.00
Micromar 44 AS/SET

4190352

Order no.	Product	Measuring range	Resolution	Details	List price	Offer price
		mm	mm		EUR	EUR
4134000	40 A	0 – 25	0.01	Glare-free matt chrome-plated display parts	66.00	53.00
4134001	40 A	25 – 50	0.01	Glare-free matt chrome-plated display parts	103.50	83.00
4134050	40 SA/SET	0 – 100	0.01	Set of 4 micrometers	386.00	309.00
4190350	44 AS/SET	6 – 12	0.001	incl. setting rings 8 mm, 10 mm	1295.00	1036.00
4190351	44 AS/SET	12 – 20	0.001	incl. setting ring 16 mm	990.00	792.00
4190352	44 AS/SET	20 – 50	0.005	incl. setting rings 25 mm, 40 mm	2240.00	1792.00
4190353	44 AS/SET	50 – 100	0.005	incl. setting rings 60 mm, 85 mm	2665.00	2132.00

Micromar 44 EWR / 844 AS

Digital 3-point internal measuring devices – precision is guaranteed

Spring Sale



2288.00
Micromar 44 EWR/SET



4191162

Measure holes

in one movement



4487762

2368.00
Micromar 844 AS/SET



Order no.	Product	Measuring range	Resolution	Details	List price	Offer price
					EUR	EUR
4191160	44 EWR/SET	6 – 12	0.001	incl. setting rings 8 mm, 10 mm	2125.00	1699.00
4191161	44 EWR/SET	12 – 20	0.001	incl. setting ring 16 mm	1850.00	1480.00
4191162	44 EWR/SET	20 – 50	0.001	incl. setting rings 25 mm, 40 mm	2860.00	2288.00
4191163	44 EWR/SET	50 – 100	0.001	incl. setting rings 60 mm, 85 mm	3430.00	2744.00
4487760	844 AS/SET	6 - 12	0.0005	incl. digital indicator 1086 R and setting rings 8 mm, 10 mm	2255.00	1804.00
4487761	844 AS/SET	12 - 20	0.0005	incl. digital indicator 1086 R and setting rings 16 mm	2015.00	1612.00
4487762	844 AS/SET	20 - 50	0.0005	incl. digital indicator 1086 R and setting rings 25 mm, 40 mm	2960.00	2368.00
4487763	844 AS/SET	50 - 100	0.0005	incl. digital indicator 1086 R and setting rings 60 mm, 85 mm	3590.00	2872.00

Detailed information on the products can be found at <https://metrology.mahr.com/en-int/>
All illustrations and figures etc. are without guarantee. All prices quoted are non-binding recommended prices. The net prices in € plus VAT are valid from April 1, 2024 to May 31, 2024

MarTest 800 S / 800 SG / 800 SM

Highly sensitive measuring

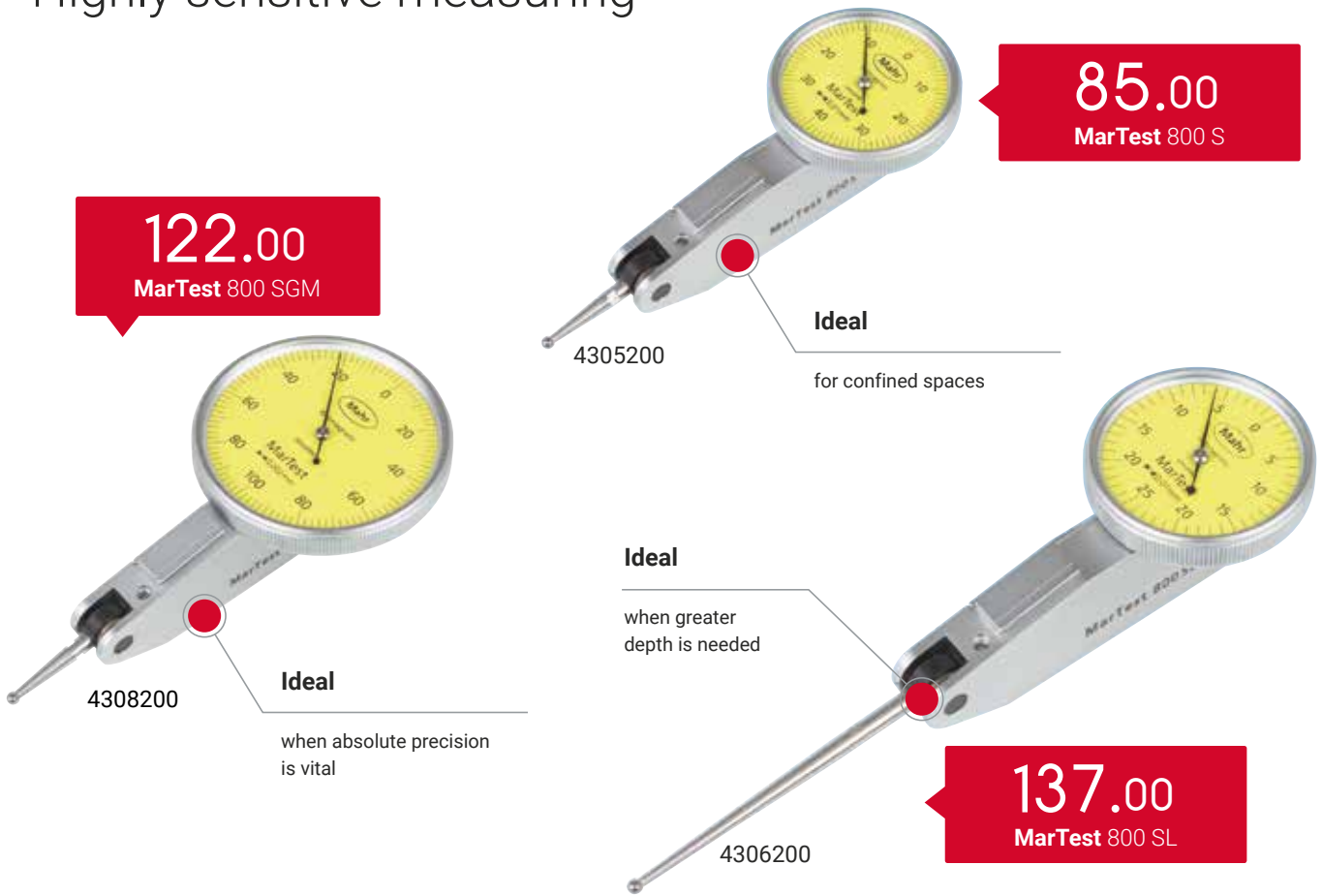

Spring Sale

MarCator | Dial indicator

MarCator 810 A



Order no.	Product	Measuring range	Graduation value	Details	List price	Offer price
		mm	mm		EUR	EUR
4305200	800 S	± 0.4	0.01	Dial ø 28 mm, measuring insert length 14.5 mm	106.00	85.00
4307200	800 SG	± 0.4	0.01	Dial ø 38 mm, measuring insert length 14.5 mm	107.00	86.00
4308150	800 SM	± 0.1	0.002	Dial ø 28 mm, measuring insert length 14.5 mm	138.00	111.00
4308200	800 SGM	± 0.1	0.002	Dial ø 38 mm, measuring insert length 14.5 mm	152.50	122.00
4306200	800 SL	± 0.25	0.01	Dial ø 28 mm, measuring insert length 41.24 mm	171.00	137.00
4311050	810 A	10	0.01	High-contrast dial face	53.00	40.00

Detailed information on the products can be found at <https://metrology.mahr.com/en-int/>
 All illustrations and figures etc. are without guarantee. All prices quoted are non-binding recommended prices. The net prices in € plus VAT are valid from April 1, 2024 to May 31, 2024

MarCator 1075 R / 1086 R / 1087 R

Practically suited to your measuring tasks

Spring Sale



146.00
MarCator 1075 R



4336010



434.00
MarCator 1087 R

4337660



345.00
MarCator 1086 R



4337620

Detailed information on the products can be found at <https://metrology.mahr.com/en-int/>
All illustrations and figures etc. are without guarantee. All prices quoted are non-binding recommended prices. The net prices in € plus VAT are valid from April 1, 2024 to May 31, 2024

MarCator 1086 R-HR / 1087 R-HR

Highest precision with a large measuring range

Spring Sale



528.00
MarCator 1086 R-HR

4337697



626.00
MarCator 1087 R-HR

4337695

Order no.	Product	Measuring range	Resolution	Details	List price	Offer price
		mm	mm		EUR	EUR
4336010	1075 R	12.5	0.01	Basic functions for static measuring tasks	182.50	146.00
4336020	1075 R	12.5	0.005	Basic functions for static measuring tasks	251.00	199.00
4336030	1075 R	12.5	0.001	Basic functions for static measuring tasks	375.00	298.00
4337130	1086 R	12.5	0.01	Practical functions for static measurement tasks	350.00	280.00
4337620	1086 R	12.5	0.0005	Practical functions for static measurement tasks	431.00	345.00
4337621	1086 R	25	0.0005	Practical functions for static measurement tasks	528.00	422.00
4337660	1087 R	12.5	0.0005	Practical functions for static and dynamic measurement tasks	543.00	434.00
4337661	1087 R	25	0.0005	Practical functions for static and dynamic measurement tasks	624.00	499.00
4337697	1086 R-HR	12.5	0.0001	High-resolution, practical functions for static measurement tasks	660.00	528.00
4337695	1087 R-HR	12.5	0.0001	High-resolution, practical functions for static and dynamic measurement tasks	783.00	626.00

Highest level of precision

Spring Sale



Integrated Wireless
 - Integrated Wireless interface
 - Sending and receiving measuring data and various parameters



Can be configured and controlled remotely using MarCom Professional Software



Bidirectional data interface via USB
 - Sending and receiving measuring data and various parameters
 - Permanent power supply via data cable
 - Possible to retrieve the device ID

#ID



Data interface via Digimatic
 - To send measuring data



Lock individual keys and functions
 Remote-controlled settings can be configured easily using MarCom Professional Software



First digital comparator indicator with touch operation

Extensive advantages:
 - Keys react even with the slightest touch
 - This prevents a measuring device from being adjusted or deformed – **maximum measuring certainty**

Hardened glass front

- Scratch and impact-resistant surface
 - Excellent protection against scratches and penetrating liquids
 - Wear-free keys react to the slightest touch

High-precision ball-bearing guide

Maximum sensitivity of the measuring system, long service life, and high loading capacity



Protection rating IP 64

Excellent protection against dust and splash water from all directions ensures optimum workshop compatibility at all times



Convenient tolerance functions

- Clear tolerance symbols
 - Colorful LED signals (red, green, yellow) to classify the measuring values
 • No go/Go/warning limit
 • No go/Go/rework

High precision inductive measuring system

Lowest measuring deviations thanks to linearization

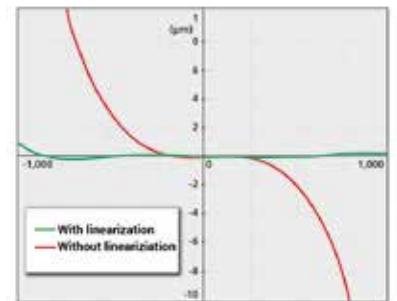

ABS system

Absolute measuring system
 The reference to the electric zero point is not lost when the device is switched off

Millimes 1002 / 1003 / 1010 / 2000 W / 2001 W

Everything reliably under control

Spring Sale

146.00
Millimes 1010



4332000

196.00
Millimes 1003



4334000



4346700



586.00
Millimes 2000 W



4346800



662.00
Millimes 2001 W



Order no.	Product	Measuring range		Display resolution		Details	List price	Offer price
		mm	µm	mm	µm		EUR	EUR
4335000	1002		± 25		0,5	Precision ball bearing of measuring spindle	440.00	352.00
4334000	1003		± 50		1	Precision ball bearing of measuring spindle	245.50	196.00
4334001	1003 XL		± 130		2	Precision ball bearing of measuring spindle	245.50	196.00
4332000	1010		± 250		10	Precision ball bearing of measuring spindle	183.00	146.00
4346700	2000 W	± 1		switchable 0.0001 ... 0.01 mm/ .000005"0005"		Inductive measuring system, practical functions for static measuring tasks	732.00	586.00
4346800	2001 W	± 1		switchable 0.0001 ... 0.01 mm/ .000005"0005"		Inductive measuring system, practical functions for static and dynamic measuring tasks	828.00	662.00

Detailed information on the products can be found at <https://metrology.mahr.com/en-int/>
All illustrations and figures etc. are without guarantee. All prices quoted are non-binding recommended prices. The net prices in € plus VAT are valid from April 1, 2024 to May 31, 2024

Millimar C 1202

Flexible evaluation and display anywhere

The Millimar C 1202 compact instrument is versatile and suitable for use with a variety of sensors.

The Millimar C 1202 represents the next generation of multichannel compact instruments for length metrology. Due to its sophisticated features such as the tilting easy-to-read display, clear menu navigation and flexible representation of measuring values, it offers maximum ergonomics and user-friendliness. Combine with an easy to change module from the N 1700 series to create just the right measuring instrument for your measuring task. Thanks to its wide range of functions, the Millimar C 1202 is extremely versatile. It can be used to tackle a multitude of measuring tasks, e.g. static and dynamic measurements as well as cone calculations. Moreover, depending on the module, measuring probes by other manufacturers may also be compatible, which will reduce your costs.

Tilting display

Measuring values can be read clearly and effortlessly from all viewing angles. The display also features a backlight.

Sturdy plastic housing

As the Millimar C 1202 is impervious to external influences, it is ideal for use in production.

Interchangeable modules

The Millimar C 1202 can be easily converted to handle different measuring tasks.

Configuring C 1202 Possible combinations with N 1700 modules

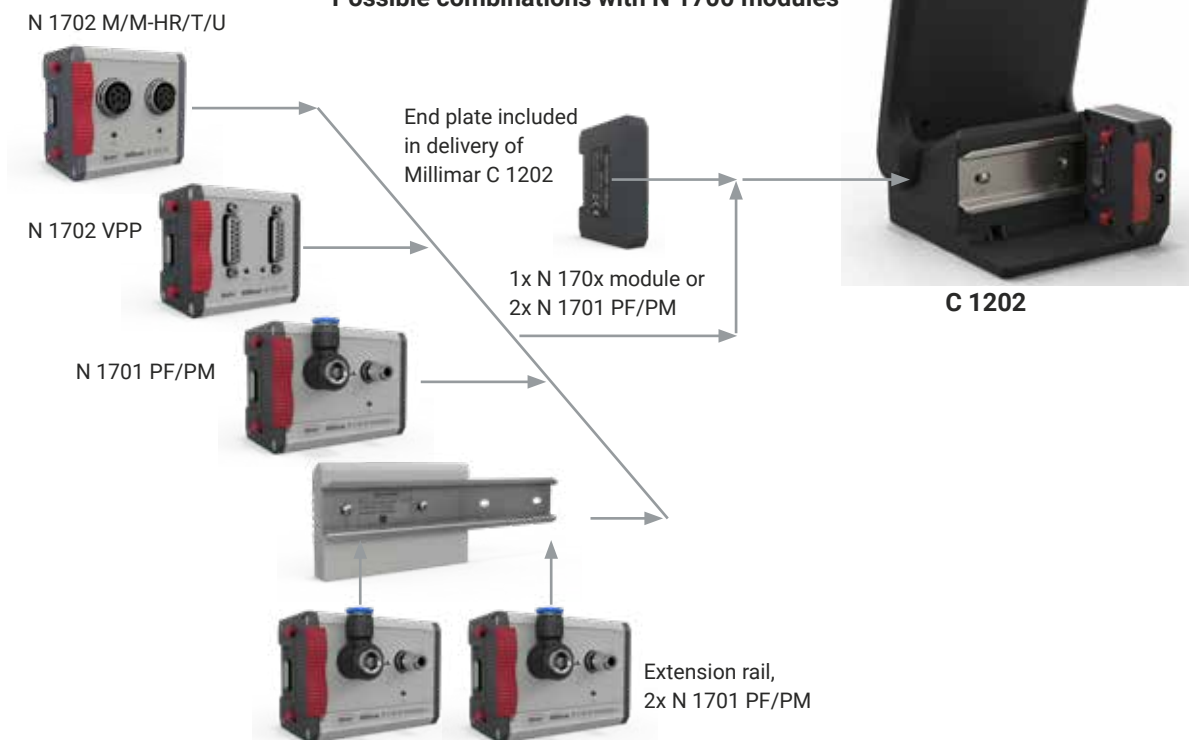

Detailed information on the products can be found at <https://metrology.mahr.com/en-int/>
All illustrations and figures etc. are without guarantee. All prices quoted are non-binding recommended prices. The net prices in € plus VAT are valid from April 1, 2024 to May 31, 2024

9

Different N 1700 modules
can be combined with Millimar C 1202



Interpret measuring results with ease

The high contrast color display provides a clear presentation of the measuring results.

Large keys

The Millimar C 1202 can also be reliably operated with gloves. Even dirt does not impede its function.



Advantages

- Three features can be displayed at the same time – for even more static and dynamic measuring tasks
- Two independent inputs via N 1700 module for the optional connection of measuring probes and pneumatic transducers
- Interchangeable modules for flexibility and compatibility
- Digimatic and USB ports for easy connection to data collection systems and evaluation software
- Programmable measuring sequences for greater productivity and reliability

Flexible setup options

Users can position the instrument on the table or fix it to the wall.

Millimar C 1200 / 1318 / P 2004

Smart and universal application

Spring Sale



5312012

948.00
Millimar C 1200 M

686.00
Millimar 1318



5313180

Compatibility:
M = Mahr

268.00
Millimar P 2004 M



5323010

Order no.	Product	Numerical display	Resolution	Details	List price	Offer price
5312012	Millimar C 1200 M	μm ± 5000	μm 0.1	High-resolution, high-contrast TFT color display	EUR 1185.00	EUR 948.00

Order no.	Product	Measuring range	Measuring force	Details	List price	Offer price
5323010	P 2004 M	mm ± 2	N 0.75	Inductive probe	EUR 335.00	EUR 268.00
5313180	1318	- 0.3 ... 1	0.25 +/-0.05	Dial test indicator inductive probe	EUR 858.00	EUR 686.00

Detailed information on the products can be found at <https://metrology.mahr.com/en-int/>
All illustrations and figures etc. are without guarantee. All prices quoted are non-binding recommended prices. The net prices in € plus VAT are valid from April 1, 2024 to May 31, 2024

Millimar C 1202 / N 1702 / P 2004 / P 1512 / P 1530

Flexible evaluation and display anywhere



5312025

812.00
Millimar C 1202



5331120

358.00
Millimar N 1702 M



5331125

761.00
Millimar N 1702 M-HR



5331161

335.00
Millimar N 1702 VPP



5315081

Order no.	Product	Numerical display	Resolution	Details	List price	Offer price
5312025	Millimar C 1202	μm $\pm 999\,999.9$	μm 0.01, 0.1, 1	High-resolution, high-contrast TFT color display	1015.00 EUR	812.00 EUR

Order no.	Product	Measuring range	Measuring force	Details	List price	Offer price
5331120	Millimar N 1702 M	mm ± 2	N	Module for 2 inductive probes, Resolution 0.1 μm	447.00 EUR	358.00 EUR
5331125	Millimar N 1702 M-HR	± 0.2		Module for 2 inductive probes, Resolution 0.1 μm	951.00 EUR	761.00 EUR
5323010	P 2004 M	± 2	0.75	Inductive probe	335.00 EUR	268.00 EUR
5313180	1318	-0.3 ... 1	0.25 +/-0,05	Inductive lever probe	858.00 EUR	686.00 EUR
5331161	Millimar N 1702 VPP			Module for incremental sensors	419.00 EUR	335.00 EUR
5315081	P 1512 V	12	0.6 – 1.2	Incremental probe	822.00 EUR	698.00 EUR
5315311	P 1530 V	30	0.4 – 1	Incremental probe	1140.00 EUR	969.00 EUR

Digimar 817 CLT

Reaching great heights with maximum precision and flexibility

Spring Sale



Best connection for secure data

Data can be transferred wirelessly or via USB cable via the MarConnect interface. Quickly print out a series of measurements with an available Bluetooth printer. Simply choose between complete measuring records in PDF format or save your measuring records as a TXT file.



Interfaces for dial indicators

An interface integrated in the slide enables the error-free measurement of the perpendicularity and straightness using the new Millimess 2000/2001W dial comparators.



6354.00
Digimar 817 CLT



Simple touch measurement

Intuitive operation via large, clearly defined keys to ensure the safe completion on measurements, setting and calculation of functions, and the creation of measuring programs via Drag & Drop.



Pivoting display

10-inch touch panel with turn/tilt joint so that it can be set individually for the work position, height of the operator, and lighting conditions.



Easy handling

The thumbwheel can be used to move the measuring slide quickly and easily start the measurement. The quick measurement function keys also automatically detect surfaces and bores.



Order no.	Product	Measuring range	Resolution	Details	List price	Offer price
		mm	mm		EUR	EUR
4429600	817 CLT	0 – 350	0.01, 0.005, 0.001, 0.0005, 0.0001	Error limit (1.8 + L/600) L in mm	7475.00	6354.00
4429601	817 CLT	0 – 600	0.01, 0.005, 0.001, 0.0005, 0.0001	Error limit (1.8 + L/600) L in mm	8160.00	6936.00
4429602	817 CLT	0 – 1000	0.01, 0.005, 0.001, 0.0005, 0.0001	Error limit (1.8 + L/600) L in mm	12415.00	10552.00

Detailed information on the products can be found at <https://metrology.mahr.com/en-int/>
All illustrations and figures etc. are without guarantee. All prices quoted are non-binding recommended prices. The net prices in € plus VAT are valid from April 1, 2024 to May 31, 2024

Digimar 814 SR

Ideal for the workshop, robust and universally applicable.

Spring Sale

Digimar 814 SR Height Measuring and Scribing Instrument

- Exact positioning by handwheel

619.00
Digimar 814 SR



4426100



Clamping lever

for quickly securing the slide unit

Handwheel

for easy positioning and measuring

Order no.	Product	Measuring range	Resolution	Details	List price	Offer price
4426100	814 SR	0 – 350 mm	0.01 mm	Digit height 12 mm, handwheel for positioning and measuring	774.00 EUR	619.00 EUR
4426101	814 SR	0 – 600 mm	0.01 mm	Digit height 12 mm, handwheel for positioning and measuring	1340.00 EUR	1072.00 EUR

Precimar SM 60 / SM 60-V

Simple and robust, ideal for production and QA

Spring Sale

Precise measuring results
Thanks to the spring-loaded measuring spindle with high-precision bearing

Mount
for measuring equipment (digital dial indicator, probes, etc.)

Clamping lever
for securing the contact

Clamping screw
for securing the support table

Lifting lever
for easy positioning of the measuring probe

5357360

1640.00
Precimar SM 60

1736.00
Precimar SM 60-V

SM 60-V
for universal use due to interchangeable measuring inserts

5357380

Application example:
Measurement of the diametral two-ball dimension of a gear

Order no.	Product	Measuring range	Application range	Mount \varnothing	Details	List price	Offer price
5357360	SM 60	mm 25	mm 0 – 60	mm 8	Table size \varnothing 60 mm	EUR 2050.00	EUR 1640.00
5357380	SM 60-V	mm 25	mm 0 – 60	mm 8	Table size \varnothing 60 mm, incl. pair of carbide anvils \varnothing 3.5 mm	EUR 2170.00	EUR 1736.00

Detailed information on the products can be found at <https://metrology.mahr.com/en-int/>
All illustrations and figures etc. are without guarantee. All prices quoted are non-binding recommended prices. The net prices in € plus VAT are valid from April 1, 2024 to May 31, 2024

Precimar ICM 100 IP

Fast & reliable data collection

The powerful USB 3.0 camera and sturdy LED lighting guarantee that all display values are clearly legible. Even when the scale or numerical display of your testpiece are not exactly centered in the image, the system will read the displayed values perfectly.

27150.00
Precimar ICM 100 IP

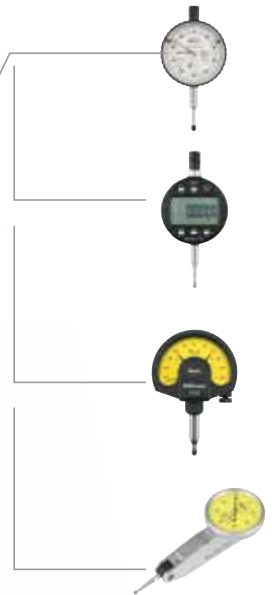

Spring Sale

One-handed operation

Using just one hand and no tools, you can move the camera and light source to the optimal height and position for your measurement: Fold down the lever, adjust the height continuously – done. Handling is easy and, thanks to spring-supported weight reduction, particularly comfortable and ergonomic.

Universal & reliable

The Precimar ICM 100 IP based on the tried-and-tested Precimar ICM 100 dial indicator test station – also known as Optimar 100. This versatile, market-tested solution can be used for checking analog and digital dial indicators as well as dial comparators by a wide range of manufacturers. It provides traceable measuring results conforming to standards in a measuring range of up to 100 mm.

5351010

Manual mode

Do you want to check your testpieces manually in individual cases? You can still do so with easy handwheel operation. In manual mode, the camera serves as a magnifying glass. Thanks to the enlarged live image, you can read the display values more easily, thus making manual work faster and more reliable.

Order no.	Product	Measuring range	Measuring uncertainty MPE_{E1}	Details	Offer price
		mm / inch	μm		EUR
5351010	Precimar ICM 100 IP	100 / 4	$0.2 + L / 250$	Incremental measuring system, USB 3.0 CMOS camera. PC, mouse, keyboard, monitor, software and commissioning are not included in the price	27150.00

Upgrade kit accessories					
5351050	for Precimar Optimar 100 (5320005)			Price excludes commissioning	on request
5351060	for Precimar ICM 100 (5351000)			Price excludes commissioning	on request
5351070	for Precimar ICM 100 (5351005)			Price excludes commissioning	on request

Detailed information on the products can be found at <https://metrology.mahr.com/en-int/>
All illustrations and figures etc. are without guarantee. All prices quoted are non-binding recommended prices. The net prices in € plus VAT are valid from April 1, 2024 to May 31, 2024

MarSurf PS 10

Mobile measuring made easy

The MarSurf PS 10 is the ideal entry level instrument for surface metrology: Its extraordinarily simple and intuitive operation, along with numerous safety functions including the automatic cutoff, make the device as easy to control as a cellphone. Due to its minimal size, it is also perfect for location-independent measurements – vertical, horizontal and even overhead if necessary. And thanks to the removable drive unit, the MarSurf PS 10 can be used flexibly in production.

The measuring instrument boasts three order options for increased flexibility: with stylus tip 2 µm, 5 µm and also a variant with a transverse drive unit (MarSurf PS 10 C2).

- Intuitive operation: As easy as using a smartphone with a rotatable display
- Creates complete PDF measuring records right in the measuring instrument and data backup as TXT, X3P, CSV and PDF files
- Customized comments for the PDF measuring record entered directly into the MarSurf PS 10
- Error-free operation thanks to an integrated, removable roughness standard
- Automatic cutoff selection, ensuring that even non-specialists get the correct measuring results

9

other optional
probes

Always at hand

The calibration standard stays in the instrument and can be checked at any time.

500 g
lightweight



Extremely easy to operate with detailed profile display

The large 4.3" high-resolution and backlit TFT touch display allows intuitive operation and precise representation of the measuring profile.

Perfect evaluation and documentation

Measuring records are automatically created in the instrument without the need for additional software.



up to
500,000
measurements
can be stored in the instrument

31
parameters
same range of functions as a
laboratory instrument

4.3"
TFT touch display
similar to a smartphone

Flexible use

The removable drive unit, in conjunction with the optional handheld support, lends this instrument added versatility where space is limited, e.g. in holes or when measuring small parts.

at least
1,200
measurements
without power supply

1995.00
MarSurf PS 10



6910230

Order no.	Product	Measuring range	Probe	Details	List price	Offer price
6910230	PS 10	μm 350	Skidded probe system	Storage capacity for min. 3900 profiles, min. 500,000 results, min. 1500 PDF protocols, expandable with microSD card up to 32 GB	EUR 2590.00	EUR 1995.00

Detailed information on the products can be found at <https://metrology.mahr.com/en-int/>
All illustrations and figures etc. are without guarantee. All prices quoted are non-binding recommended prices. The net prices in € plus VAT are valid from April 1, 2024 to May 31, 2024

MarSurf M 310

Brings added value for mobile roughness measurement

Are you used to using your smartphone to access your data anytime, wherever you are? That is exactly what Mahr's MarSurf M 310 provides you with: A versatile device for the mobile recording and evaluation of measuring data. Simple operation and a robust design

make this Mahr product perfectly suited for use in production, where dirt and dust can clog the instrument and it is often users with little prior knowledge performing the quality control.

For all those who need more

The **MarSurf M 310** has the same functions as the PS 10 but has even more crucial added benefits for you:

- 1 Print directly, document easily**
Measuring results in paper form? Sometimes still the fastest way! The mobile printer allows you to save data on thermal paper, which can then be added directly to the workpiece.
- 2 Preprogrammed measuring functions for immediate measuring success**
A variety of measuring parameters can be defined, saved and then called up on the workpiece in the device settings. Additionally, it works using a barcode scanner, which simply connects to the MarSurf M 310. This allows even workers without expert knowledge or training to determine reliable roughness parameters.
- 3 Robot ready: Integrate instrument directly in the production line**
The MarSurf M 310 and its interfaces can be directly integrated into your production lines, such as for measuring tasks on the robot arm. They control the measuring instrument remotely – conveniently from your computer, for example.

Status at a glance

Instrument status at a glance thanks to two easily visible status LEDs. Depending on the signal color, a measurement is underway, data is being transferred or an error has been detected. Standby mode shows the charging status.

Robust in every respect

Equipped for virtually any environment: The robust skidded probe system means that the measuring instrument is less sensitive to vibrations. The PHT probe is easy to clean due to its open skid.

Modern optics, perfect display

A high resolution, backlit 4.3" TFT display ensures precise display of your measuring results. It is operated directly via the touchscreen – just as you are used to with your smartphone.

IATF compliant

The MarConnect duplex interface enables the transmission of a measuring equipment ID with each measurement. This makes measuring results traceable at any time.



ISO 21920 ready

At the turn of the year 2021/22, the new roughness standards DIN 21920-1 to 3 take effect. The MarSurf M 310 is compliant with these new standards.

Software with a success guarantee

With this measuring instrument, you can reliably determine roughness parameters even without expert knowledge or training – due to intuitive software, clear menu structures and preprogrammed measuring functions.



2890.00
MarSurf M 310 SET



6910260

Order no.	Product	Measuring range	Probe	Details	List price	Offer price
6910260	MarSurf M 310 SET	µm 350	Skidded probe system 2 µm probe tip	Storage capacity for min. 3900 profiles, 1500 PDF protocols and 500,000 results, expandable with microSD card up to 32 GB	EUR 3400.00	EUR 2890.00
6910267	MarSurf M 310 SET with printer	350	Skidded probe system 2 µm probe tip	Additionally with USB/Bluetooth printer and docking station for direct printout of profiles, ADC and MRC diagram and measurement results	EUR 3900.00	EUR 3315.00

Detailed information on the products can be found at <https://metrology.mahr.com/en-int/>
All illustrations and figures etc. are without guarantee. All prices quoted are non-binding recommended prices. The net prices in € plus VAT are valid from April 1, 2024 to May 31, 2024

MarSurf M 410

Simple, innovative, flexible –
modern surface metrology
to be used by hand

Mobile recording and evaluation of measuring data has never been this easy. The MarSurf M 410 is convenient and flexible to use – just like a modern smartphone. It has a practical touch display, an integrated PDF memory, innovative accessories, and can transfer data via Bluetooth – all of which effectively simplify your workload.

Benefit from functions that only Mahr can offer you. In addition to the practical and efficient design and the flexibility this offers, the MarSurf M 410 also has an automatic filter setting by detecting the surface structure. This automatic contacting also guarantees the unmatched reliability of your measurements. The magnetic 3-point holder for the probe arm and the freely combinable accessories offer additional process security.



Advantages

- Increased efficiency thanks to large integrated memory: More than 500,000 measuring programs and 1,500 PDF reports, can be expanded by 32 GB (microSD)
- Skidless probes ensure that the roughness and waviness can be measured without an additional measuring station being required – determination of parameters R, W and P.
- Safe measuring results thanks to automated cutoff option
- Automatic zeroing ensures process and material safety
- IATF ready – simply activate/deactivate in the menu by automatically transferring the item and serial number of the measuring instrument
- Free MarCom software to transfer data

Possible to separate the display and probe system

Optionally, you can use the measuring instrument as a mini mobile measuring station, for example by simply attaching the display to the wall using the supplied pivoted docking station.



Magnetic probe holder

Probe arms can be changed quickly without tools and with additional protection: The magnetic 3-point holder ensures that the probe will not be broken in the event of a collision; it will simply be released by the magnetic holder.

Simple alignment of the probe system

The inclination is easy to correct via the menu-driven, graphic instructions.

Intuitive operation via touch display

Easy to operate just like a smartphone so that no training or introduction to the operating functions is required – you can just get started.

Creation of PDFs directly on the device

Practical: The device creates a complete PDF file without the need for additional software or transfer to a computer. Information can be added to the PDF files directly on the device.

Wireless data transmission

Connect your measuring instrument to a PC via Bluetooth and transfer your data wirelessly to Excel or another software application, for example.

Importing information using a scanner

Simply start your measuring program by scanning a QR or barcode. You do not need to enter any profile information as your saved measuring programs are linked with a corresponding code.



7525.00
MarSurf M 410 SET



6910290

Order no.	Product	Measuring range	Probe	Details	List price	Offer price
		µm			EUR	EUR
6910290	MarSurf M 410 Set	500 µm (±250 µm)	with probe arm length 45 mm bis 1500 µm (±750 µm) with probe arm length 135 mm	Storage capacity for min. 3900 profiles, 1500 PDF protocols and 500,000 results, expandable with microSD card up to 32 GB (increases the storage capacity by a factor of 320)	8850.00	7525.00
6910291	MarSurf M 410 Set (incl. printer)	500 µm (±250 µm)	with probe arm length 45 mm bis 1500 µm (±750 µm) with probe arm length 135 mm	Storage capacity for min. 3900 profiles, 1500 PDF protocols and 500,000 results, expandable with microSD card up to 32 GB (increases the storage capacity by a factor of 320)	9350.00	7950.00

Detailed information on the products can be found at <https://metrology.mahr.com/en-int/>
All illustrations and figures etc. are without guarantee. All prices quoted are non-binding recommended prices. The net prices in € plus VAT are valid from April 1, 2024 to May 31, 2024

MarSurf CD 140 AG 11

Versatile with intelligent probe system

Mahr has launched a new contour measuring machine on the market – the MarSurf CD 140 AG 11. Its probe system has a measuring range of up to 70 mm and the stylus tips can be replaced quickly and without any tools – without having to recalibrate the system.

The new contour measuring machine MarSurf CD 140 AG 11 enables the user to complete fast and precise measurements. Its flexible workpiece holder makes it particularly easy to handle, while users are also convinced by its extreme versatility – it can also be used to measure roughness. The intelligent probe system and magnetic stylus tip holder ensure the process to replace stylus tips without any tools is the most straightforward process to date. Operators can also choose from a comprehensive range of clamps and workpiece holders. The new MarSurf CD 140 AG 11 can be used in a static position or directly at the location of the workpiece.

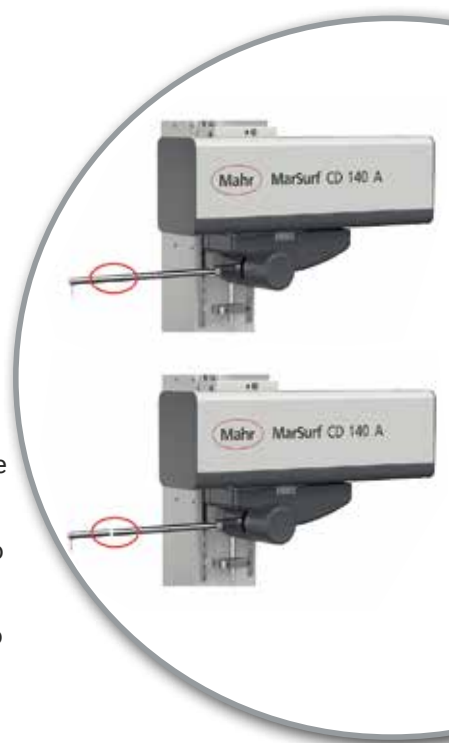

Advantages

- Comprehensive contour measurement functions – fast and simple
- Quick adjustment of the Z-axis with handles that are simple to operate
- Replacement of the stylus tip without any tools
- Travel speed in the X-axis of up to 200 mm/s
- Simple program creation or single measurement using MarWin
- Automatic evaluation, best adjustment of contours, CAD contour comparison, and a lot more
- Flexible support plate with 50 mm bore grid for KMG workpiece holder, amongst other
- Optionally expandable with option of roughness measurements ($R_z > 2 \mu\text{m}$)
- Measurement with double stylus

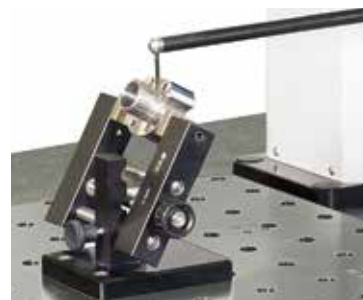
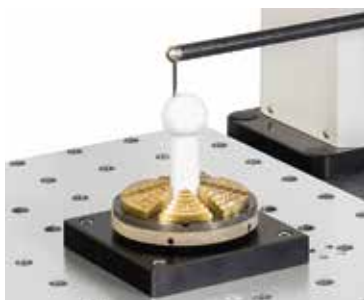

Plug-in guide stops and a wide range of standardized clamping devices as well as workpiece holders enable flexible positioning of your testpiece.

Unique probe system

The probe system with a probe arm length of 350 mm enables a quick change of stylus tips without any tools and without having to recalibrate. The automatic tracing force selection guarantees the correct tracing force is selected when replacing several stylus tips.

Manual quick adjustment

The fine adjustment is located in the Z-axis and moves the X-axis up and down.

X-axis with maximum measuring range

The high-speed X-axis is designed for a large measuring range of 140 mm.

Support plate also for large components

The 390 mm x 450 mm large plate with 50 mm matrix of holes is also suitable for large-volume workpieces. This provides a variety of flexible clamping options.

Ergonomic carrying handles

The handles on the side make it easy to transport the device.

Generous traverse path

The Y-axis can be adjusted manually with a traverse path of 60 mm.

17990.00

MarSurf CD 140 AG 11

6269200

Order no.	Product	Measuring range	Probe	Details	Offer price
6269200	MarSurf CD 140 AG 11	70 mm µm	with probe arm length 350 mm	Measuring force 4 mN to 30 mN, adjustable via software, measuring speed 0.1 mm/s to 10 mm/s, positioning speed X: 0.1 mm/s to 200 mm/s	EUR 17990.00
6269202	MarSurf CD 140 AG 11 (incl. option Roughness)	70 mm	with probe arm length 350 mm	Measuring force 4 mN to 30 mN, adjustable via software, measuring speed 0.1 mm/s to 10 mm/s, positioning speed X: 0.1 mm/s to 200 mm/s	19990.00

Detailed information on the products can be found at <https://metrology.mahr.com/en-int/>
 All illustrations and figures etc. are without guarantee. All prices quoted are non-binding recommended prices. The net prices in € plus VAT are valid from April 1, 2024 to May 31, 2024



Mahr GmbH
Carl-Mahr-Straße 1
37073 Göttingen
Germany

Reutlinger Straße 48
73728 Esslingen
Germany

Phone: +49 551 7073 800
info@mahr.com
www.mahr.com

Available from:

